

Service Manual

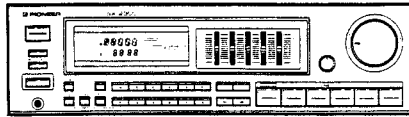

**ORDER NO.
ARP1477**

STEREO RECEIVER

SX-2300 SX-1300

MODEL SX-2300 and SX-1300 HAVE FIVE VERSIONS:

Type	Applicable model		Power requirement	Destination
	SX-2300	SX-1300		
KUC	○	○	AC120V only	U.S.A. and Canada
SD	○	○	AC110V, 120V-127V, 220V, 240V (switchable)	Kingdom of Saudi Arabia and general market
HE	○	○	AC220V, 240V (switchable)	European continent
HB	○	○	AC220V, 240V (switchable)	United Kingdom
HEZ	○	○	AC220V, 240V (switchable)	West Germany

- This manual is applicable to the SX-2300/KUC, SD, SX-1300/KUC and SD types.
- For the SX-2300/SD, SX-1300/KUC and SD types, refer to pages 30-31
- For the other types, refer to additional service manuals.
- Ce manuel pour le service comprend les explications en français de réglage. (p27)
- Este manual de servicio trata del método ajuste escrito en español. (P28)

CONTENTS

1. SAFETY INFORMATION	2	8. PACKING	25
2. SPECIFICATIONS	3	9. ADJUSTMENTS	25
3. PANEL FACILITIES	4	RÉGLAGE	27
4. EXPLODED VIEWS AND PARTS LIST ...	6	AJUSTE	28
5. SCHEMATIC DIAGRAM	9	10. IC INFORMATION	29
6. P.C. BOARDS CONNECTION DIAGRAM	13	11. FOR SX-2300/SD, SX-1300/KUC AND SX-1300/SD MODELS	31
7. ELECTRICAL PARTS LIST	22		

PIONEER ELECTRONIC CORPORATION 4-1, Meguro 1-Chome, Meguro-ku, Tokyo 153, Japan
PIONEER ELECTRONICS SERVICE INC. P.O. Box 1760, Long Beach, California 90801 U.S.A.
PIONEER ELECTRONICS OF CANADA, INC. 505 Cochrane Drive, Markham, Ontario L3R 8E3 Canada
PIONEER ELECTRONIC [EUROPE] N.V. Keetberglaan 1, 2740 Beveren, Belgium
PIONEER ELECTRONICS AUSTRALIA PTY. LTD. 178-184 Boundary Road, Braeside, Victoria 3195, Australia TEL: [03] 580-9911

YO © DEC. 1987 Printed in Japan

1. SAFETY INFORMATION

1. SAFETY PRECAUTIONS

The following check should be performed for the continued protection of the customer and service technician.

LEAKAGE CURRENT CHECK

Measure leakage current to a known earth ground (water pipe, conduit, etc.) by connecting a leakage current tester such as Simpson Model 229-2 or equivalent between the earth ground and all exposed metal parts of the appliance (input/output terminals, screwheads, metal overlays, control shaft, etc.). Plug the AC line cord of the appliance directly into a 120V AC 60Hz outlet and turn the AC power switch on. Any current measured must not exceed 0.5mA.

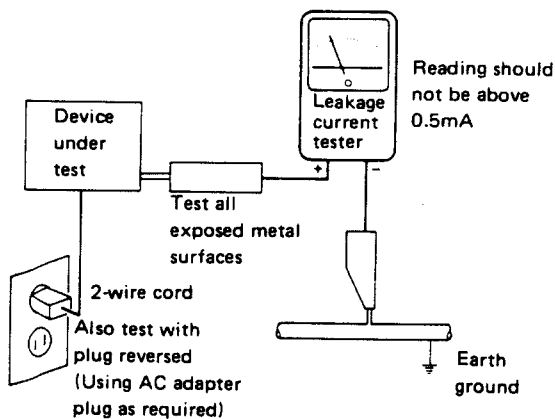

AC Leakage Test

ADVARSEL!

Lithiumbatteri. Eksplosionsfare. Udskiftning må kun foretages af en sagkyndig, og som beskrevet i servicemanualen.

Denne advarsel er angivet på produktet eller i brugsvejledningen. Ved udskiftning af lithiumbatterierne følges nedenstående anvisning. Batterierne må kun udskiftes med batterier af samme type og mærke.

ANY MEASUREMENTS NOT WITHIN THE LIMITS OUTLINED ABOVE ARE INDICATIVE OF A POTENTIAL SHOCK HAZARD AND MUST BE CORRECTED BEFORE RETURNING THE APPLIANCE TO THE CUSTOMER.

2. PRODUCT SAFETY NOTICE

Many electrical and mechanical parts in the appliance have special safety related characteristics. These are often not evident from visual inspection nor the protection afforded by them necessarily can be obtained by using replacement components rated for voltage, wattage, etc. Replacement parts which have these special safety characteristics are identified in this Service Manual.

Electrical components having such features are identified by marking with a Δ on the schematics and on the parts list in this Service Manual.

The use of a substitute replacement component which does not have the same safety characteristics as the PIONEER recommended replacement one, shown in the parts list in this Service Manual, may create shock, fire, or other hazards.

Product Safety is continuously under review and new instructions are issued from time to time. For the latest information, always consult the current PIONEER Service Manual. A subscription to, or additional copies of, PIONEER Service Manual may be obtained at a nominal charge from PIONEER.

WARNING!

Lithium batteries. Danger of explosion. Replacement must be done by qualified personnel and only by following the instructions given in the service manual.

This warning is stated on the product or in the operating instructions. When replacing the lithium batteries, follow the note below. The batteries must be replaced only by batteries of the same type and manufacture.

VAROITUS!

Litiumparistot. Räjähdyksvaara. Vaihdon saa suorittaa ainoastaan asiantunteva huoltoteknikko noudattamalla huolto-ohjeessa annettuja ohjeita.

Tämä varoitus sijaitsee laitteessa tai käyttöohjeessa. Noudata litiumparistoja vaihtaessasi alla olevaa huomautusta. Paristot on vaihdettava samantyyppisiin ja saman tehtaan valmistamiin paristoihin.

2. SPECIFICATIONS

[SX-2300]

Amplifier Section

Continuous Average Power Output is 60 watts* per channel, min., at 8 ohms from 20 Hertz to 20,000 Hertz with no more than 0.07% total harmonic distortion.

Continuous Power Output (both channel driven)*	
20 Hz - 20 kHz, T.H.D. 0.07%, 8 Ω	60 W + 60 W
Dynamic power output (with EIA test signal)	
2/4/8 ohms	145 W/125 W/85 W
Total Harmonic Distortion*	
1 kHz, 60 W, 8 Ω	0.01%
Input (Sensitivity/Impedance)	
PHONO	2.5 mV/47 kΩ
CD, VCR/LINE, TAPE 1/DAT, TAPE 2	150 mV/22 kΩ
Phono Overload Level (T.H.D. 0.01%, 1,000 Hz)	
PHONO	130 mV
Output Level	
TAPE REC	150 mV
Frequency Response	
PHONO (RIAA Equalization)	30 Hz to 20,000 Hz ±0.5 dB
CD, VCR/LINE, TAPE 1/DAT, TAPE 2	10 Hz to 70,000 Hz ±0.5 dB
Signal-to-Noise Ratio (IHF, short circuited, A network)	
PHONO	72 dB/75 dB
CD, VCR/LINE, TAPE 1/DAT, TAPE 2	97 dB/80 dB
Graphic Equalizer frequency band	
	100 Hz, 330 Hz, 1 kHz, 3.3 kHz, 10 kHz, ±8 dB

FM Tuner Section

Frequency range	87.5 MHz to 108 MHz
Usable Sensitivity	10.8 dBf, IHF (0.95 μV/75 Ω)
50 dB Quieting Sensitivity	
MONO	15.3 dBf (1.6 μV/75 Ω)
STEREO	37.1 dBf (19.5 μV/75 Ω)
Signal-to-Noise Ratio	
MONO	78 dB (at 85 dBf)
STEREO	75 dB (at 85 dBf)
Distortion	
STEREO	0.3% (1 kHz)
Alternate Channel Selectivity	55 dB (400 kHz)
Stereo Separation	35 dB (1 kHz)
Frequency Response	30 Hz to 15 kHz (±1 dB)
Antenna Input	300 Ω balanced, 75 Ω unbalanced

AM Tuner Section

Frequency range, when 10 kHz step	530 kHz to 1,700 kHz
When 9 kHz step	531 kHz to 1,602 kHz
Sensitivity	
IHF, Loop antenna	300 μV/m
Selectivity	20 dB
Signal-to-Noise Ratio	50 dB
Antenna	AM Loop Antenna

Miscellaneous

Power Requirements	
U.S., Canadian model	AC 120 Volts, 60 Hz
Other destination models	
	~AC 110 V, 120 V-127 V, 220 V, 240 V (switchable), 50/60 Hz
Power Consumption	
U.S., Canadian models	315 W (UL), 415 VA (CSA)
Other destination models	
	495 W
Dimensions	420 (W) × 120 (H) × 337 (D) mm
	16-9/16 (W) × 4-3/4 (H) × 13-9/32 (D) in
Weight (without package)	7.0 kg (15 lb 7 oz)

Furnished Parts

FM T-type Antenna	1
AM Loop Antenna	1
Operating Instructions	1

*Measured pursuant to the Federal Trade Commission's Trade Regulation rule on Power Output Claims for Amplifier.

NOTE:

Specifications and design subject to possible modification without notice due to improvements.

[SX-1300]

Amplifier Section

Continuous Average Power Output is 40 watts* per channel, min., at 8 ohms from 20 Hertz to 20,000 Hertz with no more than 0.07% total harmonic distortion.

Continuous Power Output (both channel driven)*	
20 Hz - 20 kHz, T.H.D. 0.07%, 8 Ω	40 W + 40 W
Dynamic power output (with EIA test signal)	
4/8 ohms	80 W/65 W
Total Harmonic Distortion*	
1 kHz, 40 W, 8 Ω	0.01%
Input (Sensitivity/Impedance)	
PHONO	2.5 mV/47 kΩ
CD, VCR/LINE, TAPE 1/DAT, TAPE 2	150 mV/22 kΩ
Phono Overload Level (T.H.D. 0.01%, 1,000 Hz)	
PHONO	130 mV
Output Level	
TAPE REC	150 mV
Frequency Response	
PHONO (RIAA Equalization)	30 Hz to 20,000 Hz ±0.5 dB
CD, VCR/LINE, TAPE 1/DAT, TAPE 2	10 Hz to 70,000 Hz ±0.5 dB
Signal-to-Noise Ratio (IHF, short circuited, A network)	
PHONO	72 dB/75 dB
CD, VCR/LINE, TAPE 1/DAT, TAPE 2	97 dB/80 dB
Graphic Equalizer frequency band	
	100 Hz, 330 Hz, 1 kHz, 3.3 kHz, 10 kHz, ±8 dB

FM Tuner Section

Frequency range	87.5 MHz to 108 MHz
Usable Sensitivity	10.8 dBf, IHF (0.95 μV/75 Ω)
50 dB Quieting Sensitivity	
MONO	15.3 dBf (1.6 μV/75 Ω)
STEREO	37.1 dBf (19.5 μV/75 Ω)
Signal-to-Noise Ratio	
MONO	78 dB (at 85 dBf)
STEREO	75 dB (at 85 dBf)
Distortion	
STEREO	0.3% (1 kHz)
Alternate Channel Selectivity	55 dB (400 kHz)
Stereo Separation	35 dB (1 kHz)
Frequency Response	30 Hz to 15 kHz (±1 dB)
Antenna Input	300 Ω balanced, 75 Ω unbalanced

AM Tuner Section

Frequency range, when 10 kHz step	530 kHz to 1,700 kHz
When 9 kHz step	531 kHz to 1,602 kHz
Sensitivity	
IHF, Loop antenna	300 μV/m
Selectivity	20 dB
Signal-to-Noise Ratio	50 dB
Antenna	AM Loop Antenna

Miscellaneous

Power Requirements	
U.S., Canadian model	AC 120 Volts, 60 Hz
Other destination models	
	~AC 110 V, 120 V-127 V, 220 V, 240 V (switchable), 50/60 Hz
Power Consumption	
U.S., Canadian models	175 W (UL), 235 VA (CSA)
Other destination models	
	280 W
Dimensions	420 (W) × 120 (H) × 337 (D) mm
	16-9/16 (W) × 4-3/4 (H) × 13-9/32 (D) in
Weight (without package)	6.2 kg (13 lb 11 oz)

Furnished Parts

FM T-type Antenna	1
AM Loop Antenna	1
Operating Instructions	1

*Measured pursuant to the Federal Trade Commission's Trade Regulation rule on Power Output Claims for Amplifier.

NOTE:

Specifications and design subject to possible modification without notice due to improvements.

3. PANEL FACILITIES

The illustration shows model SX-2300.

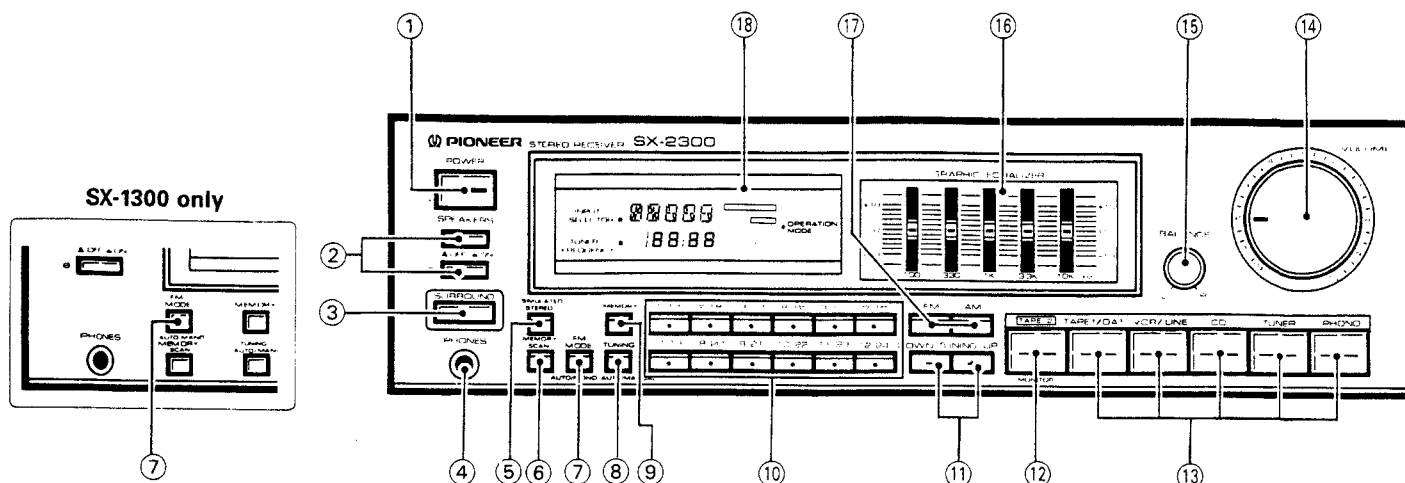

① POWER switch

When this switch is pressed, power is supplied to the unit. Press the switch again to turn power off.

② SPEAKERS switches (■ OFF, ■ ON)

These are used to select the speaker through which you wish to listen.

- A:** When the speakers connected to A terminals are in use.
- B:** When the speakers connected to B terminals are in use.
- Turn both A and B speakers to OFF position when only the HEADPHONES are in use.

NOTE: (SX-1300 only)

No sound will be heard through the speakers when both A and B switches are depressed if only one set of speakers has been connected to either A or B SPEAKERS terminals.

③ SURROUND selector switch (SX-2300 only)

By pressing the A and B SPEAKERS switches, then pressing this switch ON, you can obtain surround reproduction. If you press this switch OFF again, normal reproduction from both speakers A and B will be obtained.

④ PHONES jack

Connect the plug on your headphones to this jack. To listen to a program through the headphones, set both SPEAKERS A and B switches to the OFF position.

⑤ SIMULATED STEREO switch (SX-2300 only)

This turns monaural signals into simulated stereo sound. Use this when you wish to experience the sense of stereo presence with AM broadcasts, VCR or other monaural signal sources.

NOTE:

This function can also be used with stereo sources, but it will result in a different sound from the normal stereo sound.

⑥ MEMORY SCAN switch

Press this switch to scan the stations in the memory.

⑦ FM MODE AUTO/MONO selector switch

Use to select the auto stereo mode or monaural mode when listening to FM broadcasts. The monaural mode has been selected when the FM MONO indicator is lighted.

Auto stereo mode:

Normally leave in this mode for reception. When a stereo FM broadcast is received, it will be automatically reproduced in stereo sound.

Monaural mode:

When receiving distant stations or stations with weak broadcast signals, the input signal may be weak, thus resulting in increased noise during FM stereo broadcasts. In this event, setting the receiver to the monaural mode will reduce the noise. In this case, however, FM stereo broadcasts will be reproduced in monaural sound.

NOTE:

This switch has no effect on reception of AM broadcasts.

⑧ TUNING AUTO/MANUAL switch

Works during FM reception.

Use this switch to select either the AUTO mode or the MANUAL mode.

When the "AUTO" indicator is lit, the receiver is in the AUTO mode.

⑨ MEMORY switch

This is used to memorize stations. When the switch is pressed, the frequency indicator will flash. To memorize the frequency of any station, press the STATION CALLS switch while the frequency indicator is flashing.

⑩ STATION CALL switches

These switches are used to preset and recall desired broadcasting stations.

11 TUNING switches (DOWN, UP)

UP: The FM or AM band is scanned in the direction of increasing frequency.

DOWN: The opposite operation to that of the UP switch takes place.

12 Tape monitor switch

[TAPE 2] — Press when listening to tape playback with a tape deck.

13 FUNCTION switches

Use to select playback source.

[TAPE 1/DAT] — Press when listening to tape playback with a cassette tape deck or digital audio tape deck.

[VCR/LINE] — Press when listening to programs from a component connected to the VCR/LINE terminals.

[CD] — Press when listening to compact disc playback with a CD player.

[TUNER] — Press when listening to AM or FM broadcasts with a tuner.

[PHONO] — Press when listening to record playback on a turntable.

14 VOLUME control

Use to adjust volume level.

15 BALANCE control

Should normally be left in the center position. Adjust balance if the sound is louder from one of the speakers. If the right side is louder, turn toward the LEFT position and if the left side is louder, turn toward the RIGHT position.

16 GRAPHIC EQUALIZER controls

The equalizer is divided into five frequency ranges (100 Hz, 330 Hz, 1 kHz, 3.3 kHz, 10 kHz) to tailor music to the individual taste of the listener.

17 Band Selector switches

These switches are used to select either AM or FM reception.

AM: Push this switch for AM reception.

FM: Push this switch for FM reception.

18 OPERATION DISPLAY panel

- (a) Indicates the function selected by the function switches.
- (b) Indicates frequency or channel (STATION CALL number).
- (c) SURROUND indicator
- (d) SIMULATED STEREO indicator
- (e) TAPE monitor indicates
- (f) FM STEREO indicator
- (g) AUTO tuning indicator
- (h) FM MONO indicator
- (i) TUNED indicator

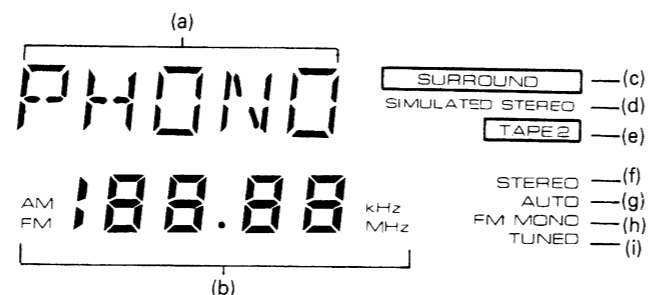

4. EXPLODED VIEWS AND PARTS LIST

NOTES:

- Parts without part number cannot be supplied.
- The Δ mark found on some component parts indicates the importance of the safety factor of the part. Therefore, when replacing, be sure to use parts of identical designation.
- For your parts Stock Control, the fast moving items are indicated with the marks \star and \star .
- $\star\star$ **GENERALLY MOVES FASTER THAN \star**
This classification shall be adjusted by each distributor because it depends on model number, temperature, humidity, etc.
- Parts marked by "●" are not always kept in stock. Their delivery time may be longer than usual or they may be unavailable.

Parts List

Mark	No.	Parts No.	Description	Mark	No.	Parts No.	Description
	1	AWZ1491	Complex assembly		36	AWZ1492	Control assembly
Δ $\star\star$	2	2SA1264N	Q3,Q4		37	VMZ26P040FZK	Screw
Δ $\star\star$	3	2SC3181N	Q1,Q2	Δ	38	AKX-507	S2 Voltage selector switch
Δ	4	ATS1116	Power Transformer T1		39	ASH-004	S3 Slide switch
Δ	5	AKP1015	AC Socket 1P		40	AKR-038	Fuse Holder
					41	AEK-122	Fuse (FU2 2A)
Δ $\star\star$	6	AEK-100	Fuse (FU1 4A)		101		SP switch assembly
Δ	7	AEX-008	Lithium battery		102		SP Terminal assembly
	8	AEC-784	Leg assembly		103		Power SW assembly
	9	AAB1010	Rotary Knob (BALANCE)		104		Terminal (GND)
	10	AAB1058	Rotary Knob (VOLUME)		105		Chassis
	11	AAD1152	Knob (POWER)		106		Rear Panel
	12	AAD1162	Knob (SURROUND)		107		Bottom Plate
	13	AAD1295	Knob (SPEAKERS)		108		Heat sink Holder
	14	AAD1296	Knob Array (TAPE2, TAPE1/DAT, VCR/LINE, CD, TUNER, PHONO)		109		Heat sink
	15	AAK1400	FL Filter				
	16	AAK1401	Sheet Panel				
	17	AAM-030	Friction Plate				
	18	AMB1283	Panel base				
	19	ANB1166	Front Panel				
	20	AZN1466	Bonnet case				
	21	ABH1034	Coil spring				
	22	AEP-313	Mica sheet				
	23	ABA-297	Screw				
	24	ABA-298	Screw(3 x 8)				
	25	ABA1009	Screw(3 x 6)				
	26	ABA1011	Screw(3 x 6)				
	27	ABA1021	Screw(3 x 10)				
	28	ABA1052	Screw(3 x 12)				
	29	ABN-065	Nut				
Δ	30	ADG1031	AC Power cord				
	31	BBT30P080FZK	Screw				
	32	BBZ26P080FMC	Screw				
	33	BPZ30P080FZK	Screw				
	34	NK70FUC	Nut				
	35	VMZ30P060FMC	Screw				

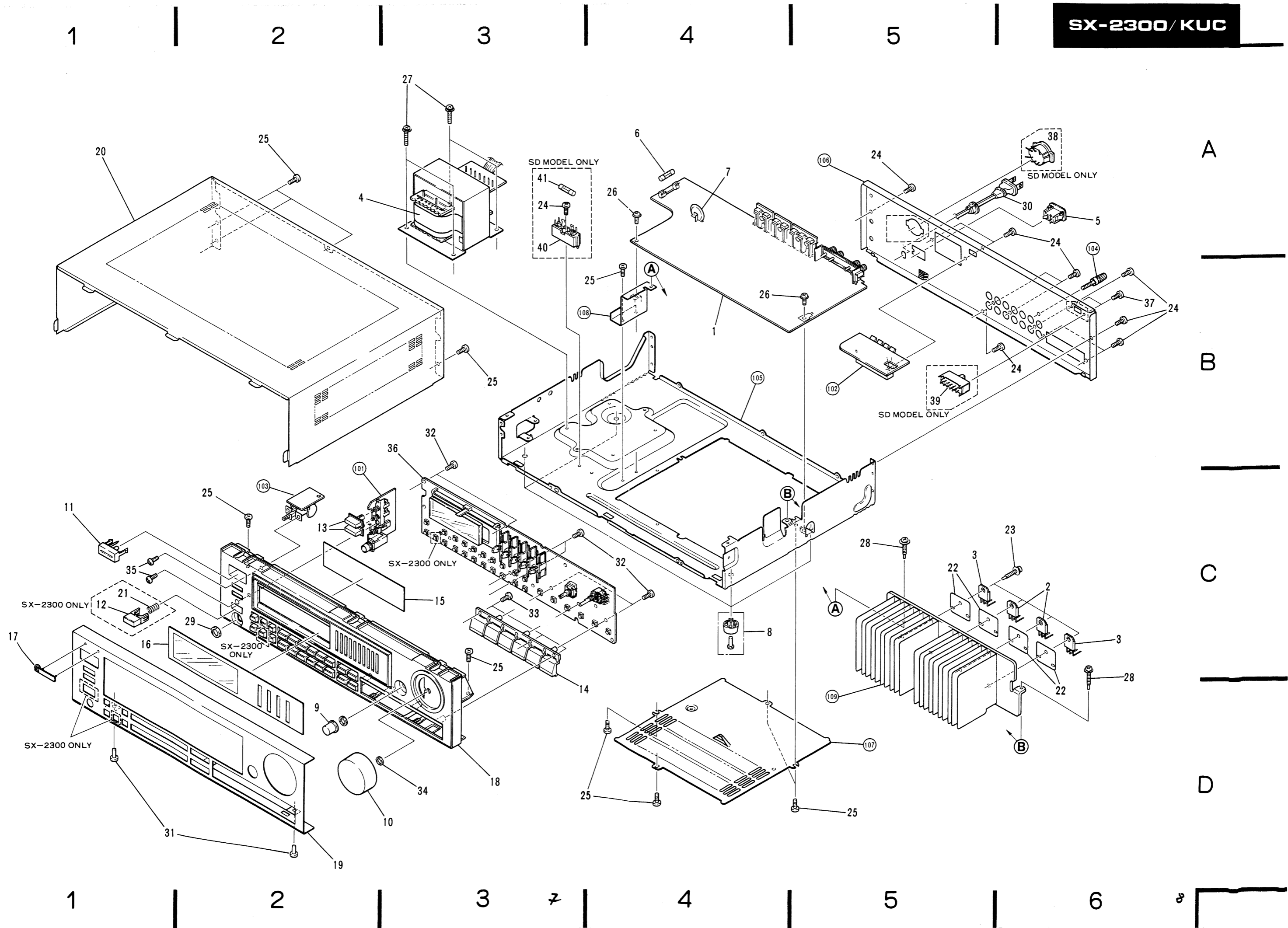

5. SCHEMATIC DIAGRAM

A

B

C

D

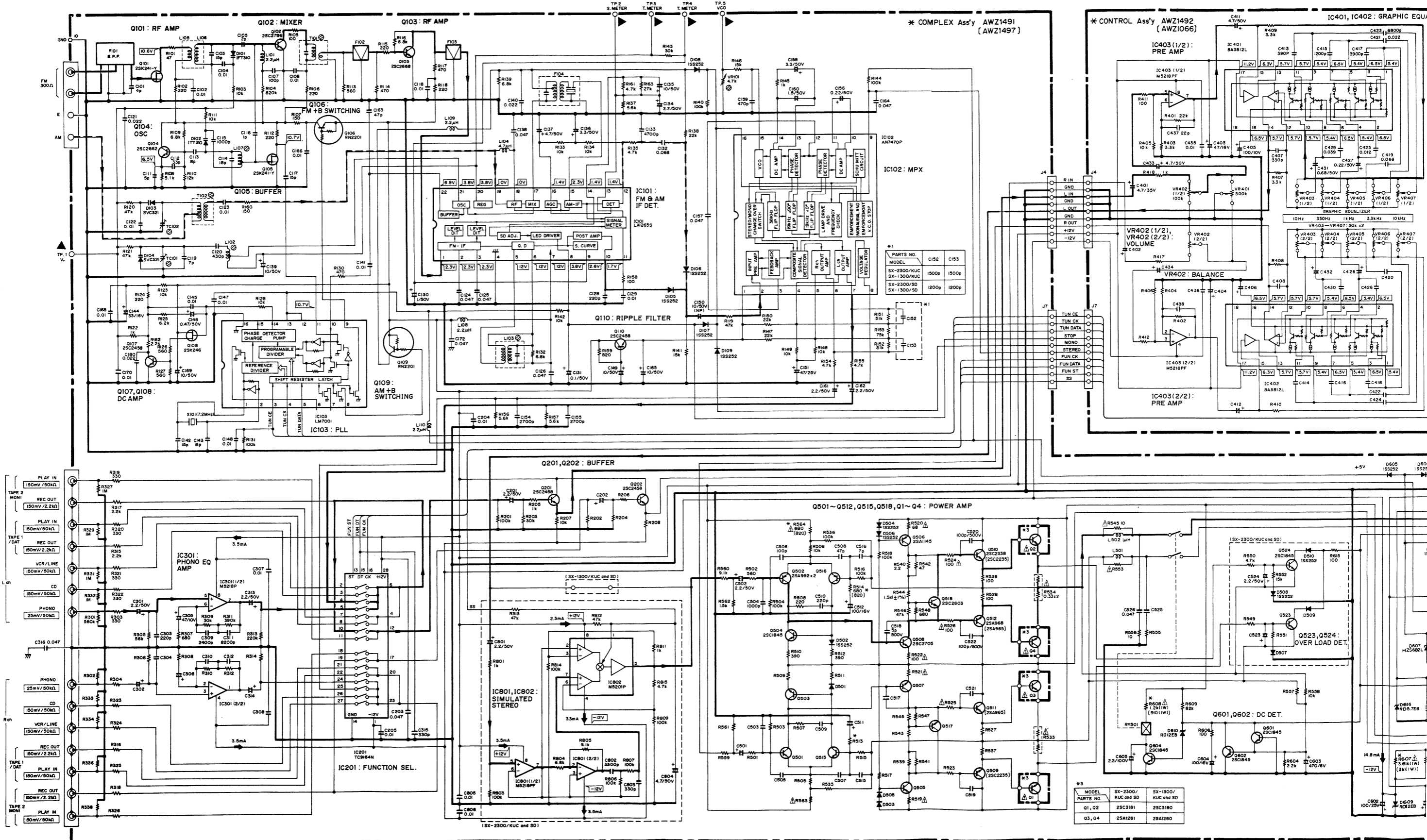

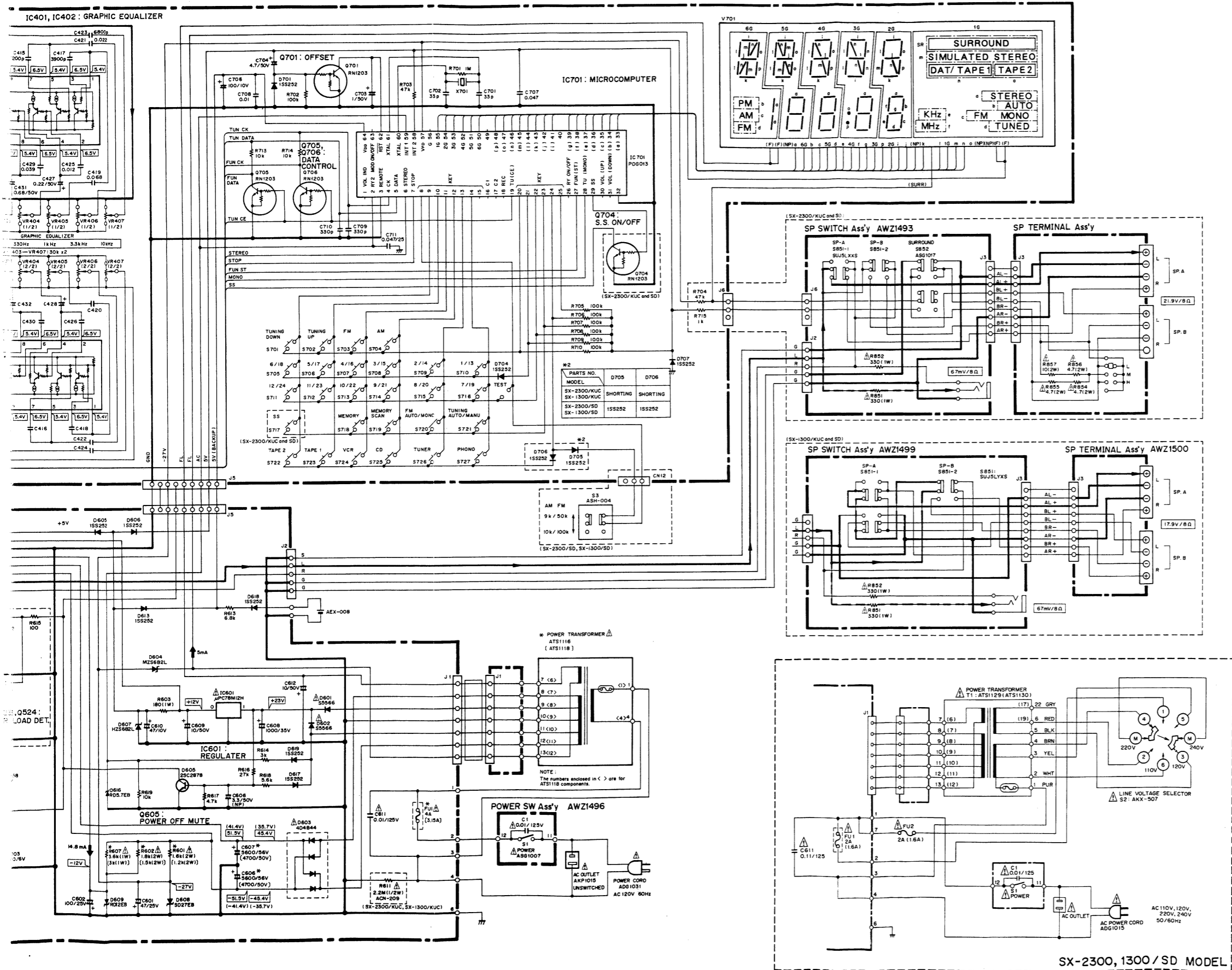

1. RESISTORS:
Indicated in Ω, ¼W, ½W, ±5% tolerance unless otherwise noted k : kΩ,
M : MΩ, (F) : ±1%, (G) : ±2%, (K) : ±10% (M) : ±20% tolerance

2. CAPACITORS:
Indicated in capacity (μF)/voltage (V) unless otherwise noted p : pF
Indication without voltage is 50V except electrolytic capacitor.

3. VOLTAGE, CURRENT:
□ : DC voltage (V) at no input signal
Value in () is DC voltage at rated power.
← mA : DC current at no input signal

4. OTHERS:
→ Signal route.
⊗ : Adjusting point.
The Δ mark found on some component parts indicates the importance of the safety factor of the part. Therefore, when replacing, be sure to use parts of identical designation.
* marked capacitors and resistors have parts numbers.

This is the basic schematic diagram, but the actual circuit may vary due to improvements in design.

5. SWITCHES
- S701 : TUNING DOWN
 - S702 : TUNING UP
 - S703 : FM
 - S704 : AM
 - S705 : 6/18
 - S706 : 5/17
 - S707 : 4/16
 - S708 : 3/15
 - S709 : 2/14
 - S710 : 1/13
 - S711 : 12/24
 - S712 : 11/23
 - S713 : 10/22
 - S714 : 9/21
 - S715 : 8/20
 - S716 : 7/19
 - S717 : SS (SD MODEL ONLY)
 - S718 : MEMORY
 - S719 : MEMORY SCAN
 - S720 : FM AUTO/MONO
 - S721 : TUNING AUTO/MANU
 - S722 : TAPE 2
 - S723 : TAPE 1
 - S724 : VCR
 - S725 : CD
 - S726 : TUNER
 - S727 : PHONO
- S1 : POWER
 - S851-1 : SP-A ON-OFF
 - S851-2 : SP-B ON-OFF
 - S852 : SURROUND ON-OFF (SX-2300 ONLY)
 - S854 : SURROUND LEVEL L/M/H
 - S3 : (SD MODEL ONLY)

Note : This general circuit diagram is based on SX-2300/KUC.

- Components marked with * for SX-2300 differ from those for SX-1300. Figures enclosed in () are for SX-1300.
- Figures enclosed in □ indicate DC voltage values when SX-1300 has received no signal.
- Figures enclosed in () indicate DC voltage values when SX-1300 yields rated output.
- Circuits enclosed in [] are necessary for the specified models.
- Assembly Nos. in red are for SX-1300.

A

B

C

D

SX-2300, 1300 / SD MODEL

6. P.C. BOARDS CONNECTION DIAGRAM

NOTE

1. This P.C.B connection diagram is viewed from the parts mounted side.
2. The parts which have been mounted on the board can be replaced with those shown with the corresponding wiring symbols listed in the following Table.

P.C.B. pattern diagram indication	Corresponding part symbol	Part Name
		Transistor
		Radiator type transistor
		Diode
		Resistor
		Capacitor (Polarity)
		Capacitor (Non-polarity)

Others

P.C.B. pattern diagram indication	Part Name
IC	IC
S	Switch
RY	Relay
L	Coil
F	Filter
VR	Variable resistor or Semi-fixed resistor

3. The capacitor terminal marked with ⊙ (double circles) shows negative terminal.
4. The diode terminal marked with ⊙ (double circles) shows cathode side.
5. The transistor terminal to which E is affixed shows the emitter.

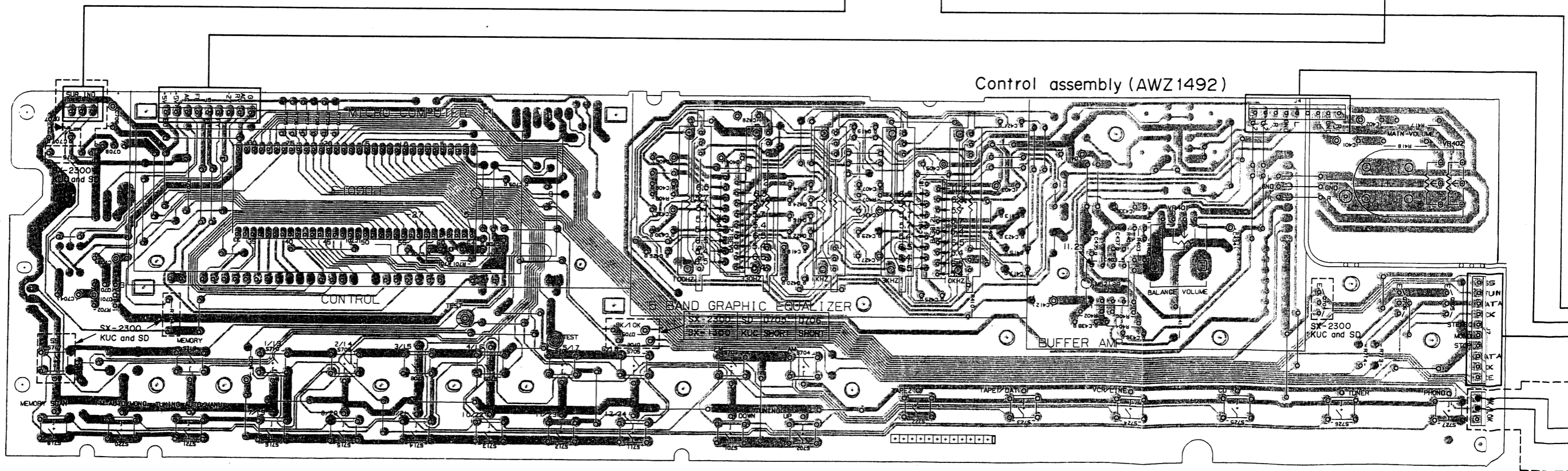
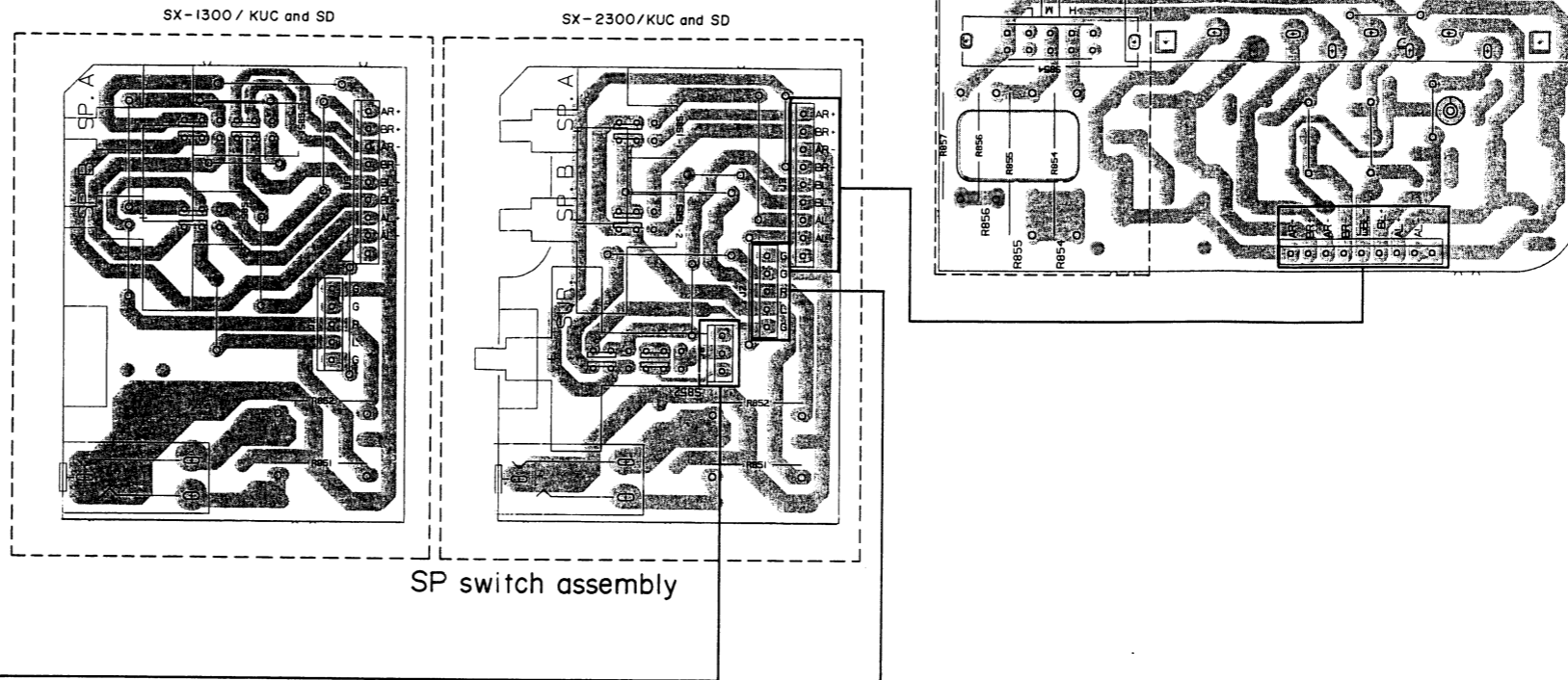

Q708 Q701 IC701 X701 IC402 IC401 Q704 Q706 Q705

1 2 3 4 5 6 14

7

8

9

10

11

IC601

Q605

Q601 Q602 Q604

Q516 IC802 Q502
Q506 Q510 Q504 Q508 Q512
Q523 Q524

Q201

IC801 Q202 IC201
Q515 Q501 Q505 Q503 Q507
Q509 Q511 Q517 Q518

IC301

IC102 Q110

Q102

Q101

Q105 Q104 Q106
IC101 Q107 Q109
Q108 IC103

ATTENTION POUR LES PRECAUTIONS CONTINUELLES CONTRE L'INCENDIE LES FUSIBLES A REMPLACER DOIVENT ETRE LES MEME TYPES ET NORMES.

CAUTION FOR CONTINUED PROTECTION AGAINST FIRE HAZARD, REPLACEMENT FUSES SHOULD BE OF THE SAME TYPE AND RATINGS.

UNIQUEMENT SX-2300/KUC SX-1300/KUC

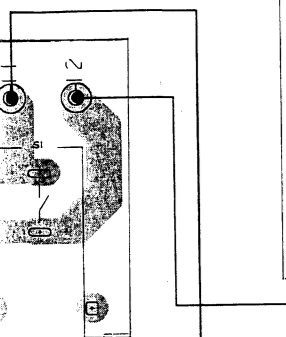

Power SW assembly

POWER TRANSFORMER

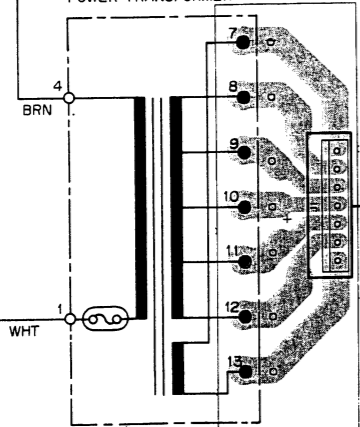

POWER CORD

AC OUTLET UNSWITCHED AC 120V 60Hz

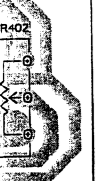

SX-2300/SD SX-1300/SD

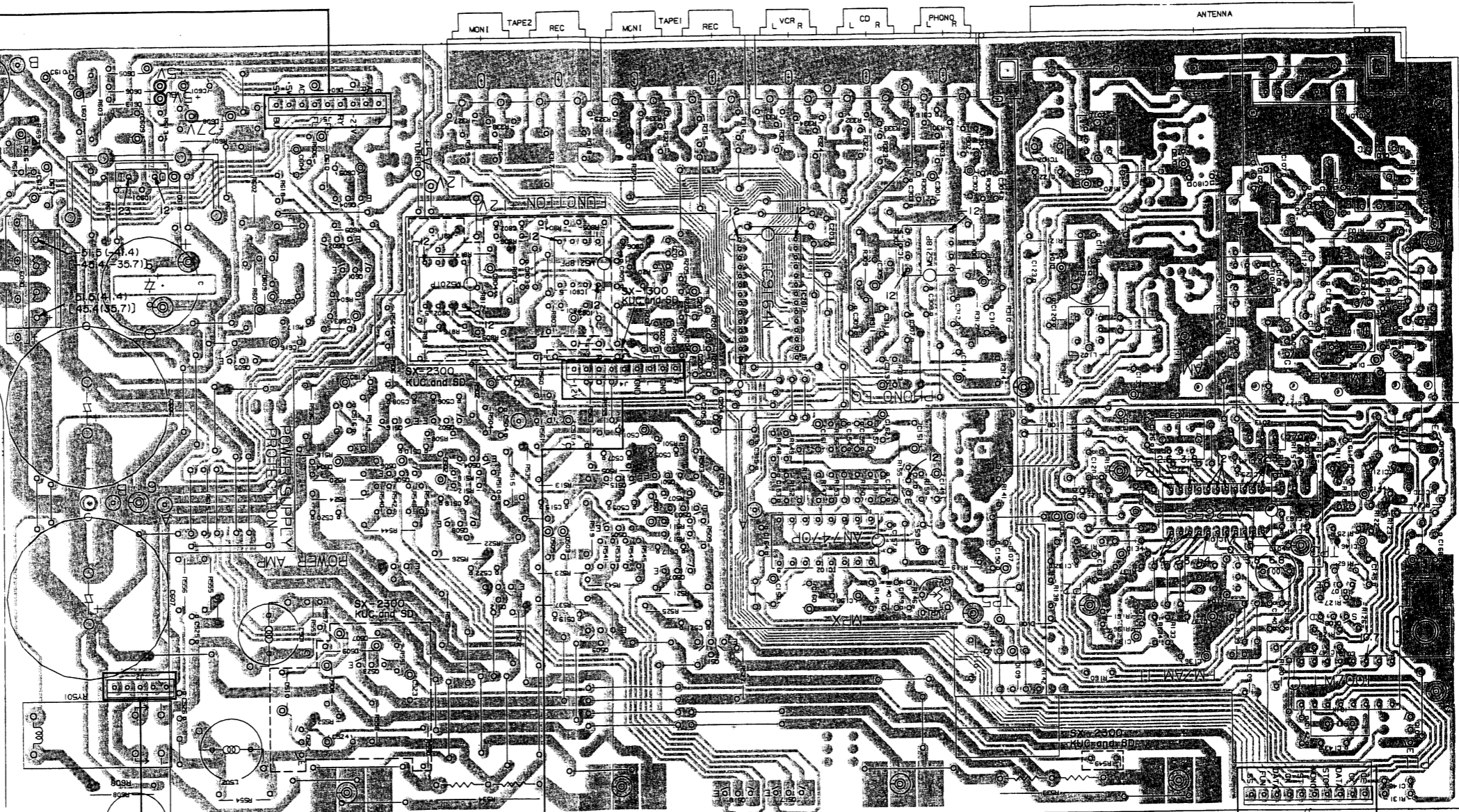
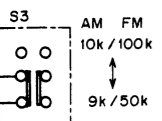

Complex assembly (AWZ1491)

A

B

C

D

14

7

8

9

15

10

11

16

12

NOTE:
This picture shows the foil side of the
printed circuit.

A

B

C

D

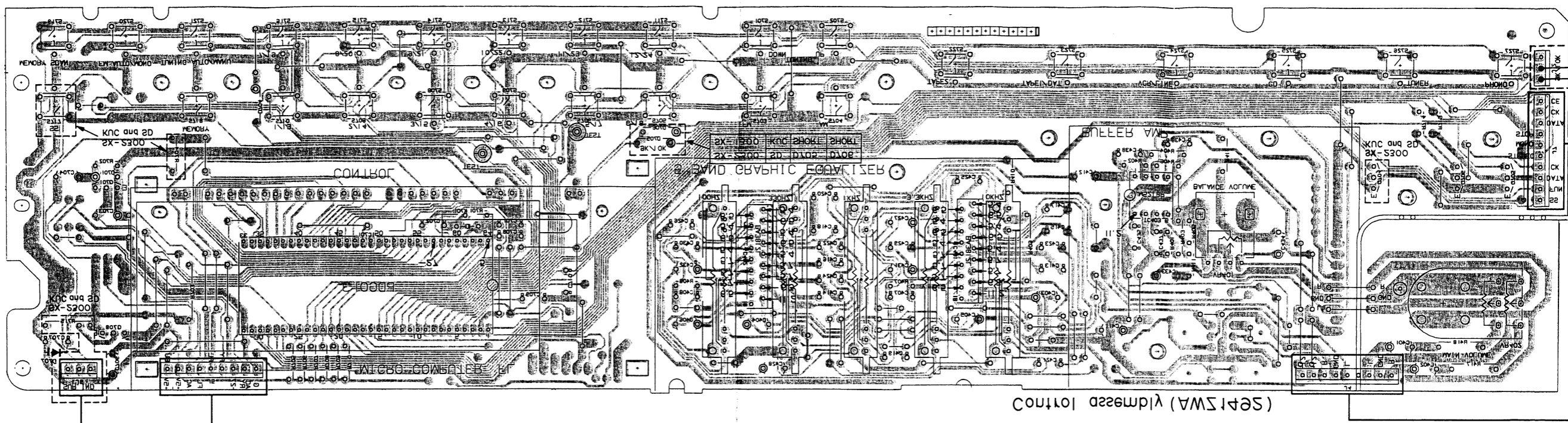

(SEPIZWA) yldmssad lortnoq

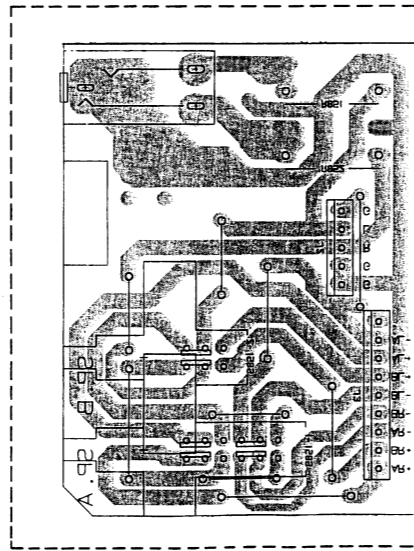

2X-5200 KUC bnd 2D

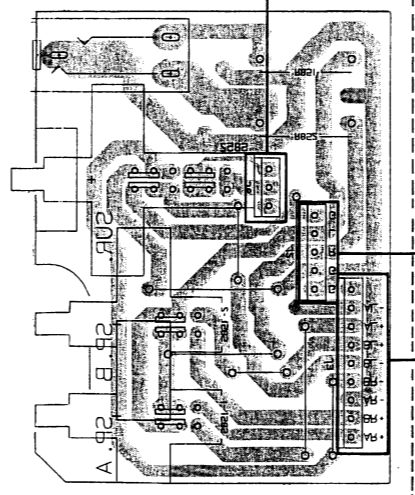

2X-5300 KUC bnd 2D

2D switch assembly

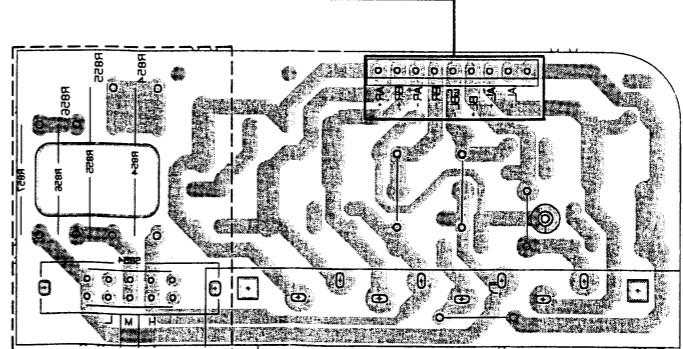

2D terminal assembly

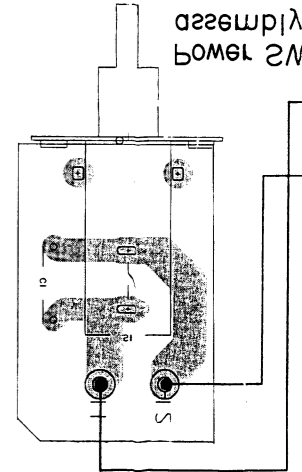

2N power assembly

8070
1070

10701

107X

104C1

104C1

4070

3070

2070

↓

5

3

4

2

1

External Appearance of Transistors and ICs

AN7470P

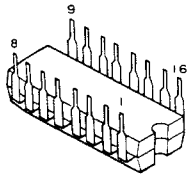

M5201P

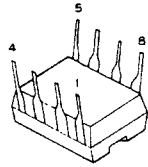

**M5218P
M5218PF**

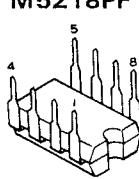

TC9164N

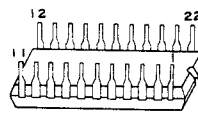

μPC78M12H

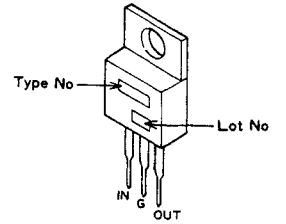

**2SA1145
2SC2705
2SC2878**

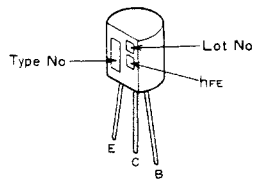

2SA968

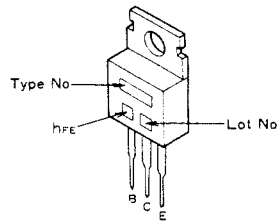

**2SA992
2SC1845**

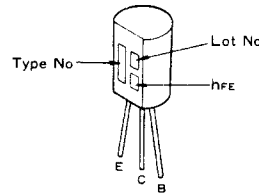

2SC2458

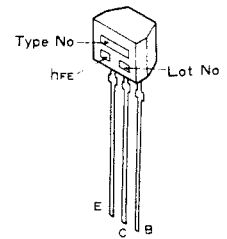

2SC2603

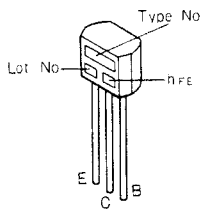

2SC2668

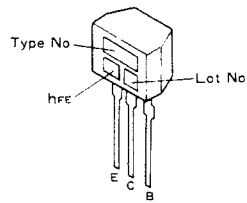

2SC2786

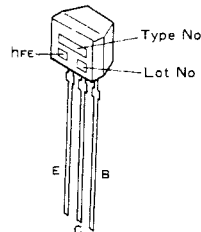

2SK246

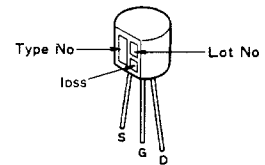

BA3812L

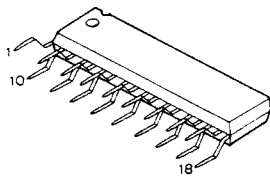

PDG013

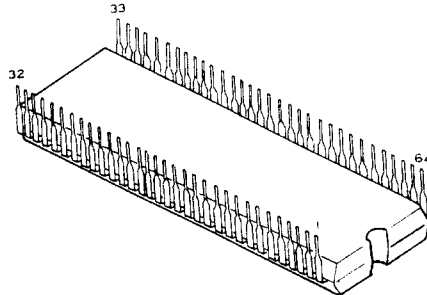

**2SC2235
2SA965**

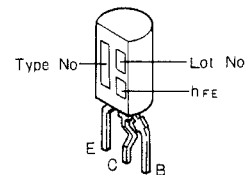

LA1265S

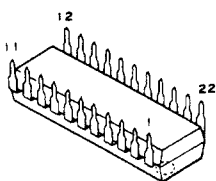

LM7001

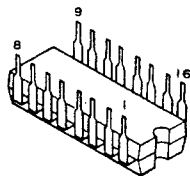

2SC2238

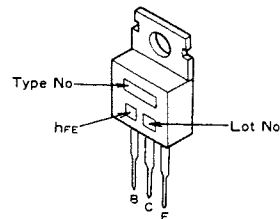

RN1203

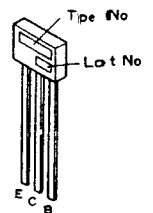

7. ELECTRICAL PARTS LIST

NOTES:

- Parts without part number cannot be supplied.
- Parts marked by "⊙" are not always kept in stock. Their delivery time may be longer than usual or they may be unavailable.
- The Δ mark found on some component parts indicates the importance of the safety factor of the part. Therefore, when replacing, be sure to use parts of identical designation.
- For your parts Stock Control, the fast moving items are indicated with the marks $\star\star$ and \star .
- $\star\star$ **GENERALLY MOVES FASTER THAN \star**
This classification shall be adjusted by each distributor because it depends on model number, temperature, humidity, etc.
- When ordering resistors, first convert resistance values into code form as shown in the following examples.

Ex. 1 When there are 2 effective digits (any digit apart from 0), such as 560 ohm and 47k ohm (tolerance is shown by J = 5%, and K = 10%).

560 Ω	56 $\times 10^1$	561.....	RD1/4PS	Δ	Δ	Δ	J
47k Ω	47 $\times 10^3$	473.....	RD1/4PS	Δ	Δ	Δ	J
0.5 Ω	0R5.....		RN2H	Δ	Δ	Δ	K
1 Ω	010.....		RS1P	Δ	Δ	Δ	K

Ex. 2 When there are 3 effective digits (such as in high precision metal film resistors).

5.62k Ω	562 $\times 10^1$	5621.....	RN1/4SR	Δ	Δ	Δ	F
----------------	-------------------	-----------	---------	----------	----------	----------	---

Miscellaneous Parts

P.C. BOARD Assemblies

Mark	Symbol & Description	Part No.
	Complex assembly	AWZ1491
	Control assembly	AWZ1492
	SP Switch assembly	
	SP Terminal assembly	
	Power SW assembly	

Mark	Symbol & Description	Part No.
$\star\star$	Q106,Q109Q	RN2201
$\star\star$	Q505,Q506	2SA1145
$\star\star$	Q511,Q512	2SA968
$\star\star$	Q501,Q502,Q515,Q516	2SA992
$\star\star$	Q503,Q504,Q523,Q524,Q601,Q602,Q604	2SC1845

OTHERS

Mark	Symbol & Description	Part No.
Δ $\star\star$	Q3,Q4	2SA1264N
Δ $\star\star$	Q1,Q2	2SC3181N
Δ \star	T1 Power Transformer (AC120V)	ATS1116
Δ	AC Socket (1P)	AKP1015
Δ $\star\star$	FU1 Fuse (4A/125V)	AEK-100
Δ	Lithium battery	AEX-008
Δ	AC Power cord	ADG1031

$\star\star$	Q509,Q510	2SC2238
$\star\star$	Q107,Q110,Q201,Q202	2SC2458
$\star\star$	Q517,Q518	2SC2603
$\star\star$	Q103,Q104	2SC2668
$\star\star$	Q507,Q508	2SC2705
$\star\star$	Q102	2SC2786
$\star\star$	Q605	2SC2878
$\star\star$	Q101,Q105	2SK241
$\star\star$	Q108	2SK246

Complex assembly (AWZ1491)

SEMICONDUCTORS

Mark	Symbol & Description	Part No.
$\star\star$	IC102 MPX IC	AN7470P
$\star\star$	IC101 AM/FM IC	LA1265S
$\star\star$	IC103 PLL IC	LM7001
$\star\star$	IC802 OP-AMP IC	M5201P
$\star\star$	IC301 OP-AMP IC	M5218P
$\star\star$	IC801 OP-AMP IC	M5218PF
$\star\star$	IC201 E-SW IC	TC9164N
$\star\star$	IC601	μ PC78M12H

\star	D604,D607	HZS6B2L
\star	D101,D102	ITT310
\star	D609,D610	RD12EB
\star	D608	RD27EB
\star	D616	RD5.1EB

\star	D103,D104	SVC321C2 (SVC321D2)
\star	D601,D602	S5566
\star	D105-D109,D501-D510,D605,D606,D613,D617-D619	1SS252
\star	D603	4D4B44

RELAY

Mark	Symbol & Description	Part No.
$\star\star$	RY501 Relay	ASR-112

COILS & TRANSFORMERS

Mark	Symbol & Description	Part No.
T102	AM Antenna transformer	ATB-095
T101	FM Matching transformer	ATE-063
L102	AM OSC Coil	ATB-114
L106	FM Coil	ATC1002
L105	FM Coil	ATC1004
L107	FM Coil	ATC1011
L103	FM Detector Coil	ATE079
L501,L503	AF Choke Coil	ATH1004
L101,L108-L110	Indicator	LAU2R2M
L104	Indicator	LTA472J
F102,F103	FM Ceramic filter	ATF-126
F101	FM Band passfilter	ATF-155
F104	AM Ceramic filter	ATF-208

CAPACITORS

Mark	Symbol & Description	Part No.
C611	Ceramic capacitor	ACG1002
C606,C607	Electolytic capacitor	ACH1031
C116		CCDSL010C50
C517,C518		CCCSL050C500
C519-C522		CCCSL101K500
C128,C303,C304,C509,C510		CCCSL221J50
C507,C508		CCCSL470J50
C101		CCDCH040C50
C119,C515,C516		CCDCH070D50
C113		CCDCH080D50
C111,C117,C142,C143		CCDCH150J50
C112		CCDCH330J50
C103		CCDRH150J50
C105		CCDSL020C50
C107,C505,C506		CCDSL101J50
C163		CCDSL470J50
C114		CCDTH180J50
C150		CEANP100M50
C616		CEANP3R3M50
C156		CEASR22M50
C146		CEASR47M50
C131		CEASOR1M50
C130		CEASO10M50
C160		CEAS1R5M50
C135,C139,C149,C165,C169, C609,C612		CEAS100M50
C604		CEAS101M16
C511,C512		CEAS101M16
C602		CEAS101M25
C608		CEAS102M35
C605		CEAS2R2M100
C134,C161,C162,C201,C202, C301,C302,C313,C314,C501, C502,C523,C524,C801		CEAS2R2M50

Mark	Symbol & Description	Part No.
C136,C158		CEAS3R3M50
C144		CEAS330M16
C137,C804		CEAS4R7M50
C305,C306,C610		CEAS470M10
C151		CEAS470M25
C603		CEAS471M6
C133		CKCYB472K50
C121,C140		CKCYF223Z50
C115,C503,C504		CKDYB102K50
C154,C155		CKDYB272K50
C315,C803		CKDYB331K50
C102,C104,C108,C118,C122, C123,C129,C141,C145,C147, C148,C166,C168,C170,C204, C205,C307,C308,C805,C806		CKDYF103Z50
C180		CKDYF223Z50
C124,C125,C138,C157,C164, C203,C316		CKDYF473Z50
C126,C172		CKDYX473M25
C152,C153		CQMA152K50
C309,C310		CQMA242J50
C802		CQMA333K50
C525,C526		CQMA473K50
C132		CQMA683J50
C311,C312		CQMA822J50
C120		CQSA431J50
C159		CQSA471J50
C601		CEHAQ470M35
TC101,TC102 Ceramic Trimmer		ACM-O15

RESISTORS

Mark	Symbol & Description	Part No.
VR101	Semi-fixed resistor	VRTB5VS472
R533,R534		ACN-139
R611	Cardom composition resistor	ACN-209
R519,R520,R527,R528,R537, R538,R553-R556		RD1/4P MF□□□J
R307-R312,R513-R516,R614, R613		RD1/4P M□□□J
R521-R526,R615		RFA1/4PS101J
R543,R544		RN1/4P Q1501F
R607		RS1LMF362J
R603,R608		RS1PMF□□□J
R601,R602		RS2LMF□□□J
Other resistors		RD1/8P M□□□J

OTHERS

Mark	Symbol & Description	Part No.
	Terminal 4P (ANTENNA)	AKA1009
	Terminal 4P (TAPE1,TAPE2)	AKB1007
	Terminal 6P (VCR,CD,PHONO)	AKB1024
	X101 Crystal resonator	ASS1005

Control assembly (AWZ1492)

SEMICONDUCTORS

Mark	Symbol & Description	Part No.
★★	IC401,IC402	BA3812L
★★	IC403	M5218PF
★★	IC701	PDG013
★★	Q701,Q704-Q706	RN1203
★	D701,D704,D707	1SS252

SWITCHES

Mark	Symbol & Description	Part No.
★★	S701-S727 Tact Switch (TUNING, FM, AM, 1~24, MEMORY, TUNING AUTO / MANU, MEMORY SCAN, SS, TAPE2, TAPE1 / DAT, VCR / LINE, CD, TUNER, PHONO)	ASG-711

CAPACITORS

Mark	Symbol & Description	Part No.
	C437,C438	CCCSL220J50
	C701,C702	CCDCH330J50
	C427	CEASR22M50
	C431,C432	CEASR68M50
	C703	CEAS010M50
	C405,C406,C706	CEAS101M10
	C411,C433,C704	CEAS4R7M50
	C403,C404	CEAS470M16
	C428	CEJAR22M50
	C401,C402,C412,C434	CEJA4R7M35
	C415,C416	CKDYB122K50
	C407,C408,C709,C710	CKDYB331K50
	C413,C414	CKDYB391K50
	C435,C436,C708	CKDYF103Z50
	C707	CKDYF473Z50
	C425,C426	CQMA123K50
	C421,C422	CQMA223K50
	C417,C418	CQMA392K50
	C429,C430	CQMA393K50
	C423,C424	CQMA682K50
	C419,C420	CQMA683K50
	C711	CKDYX473M25

RESISTORS

Mark	Symbol & Description	Part No.
	VR401 Variable resistor	ACS1016
	VR402 Variable resistor	ACT1040
	VR403-VR407 Variable resistor	ACU1020
	Other resistor	RD1/8PM□□□J

OTHERS

Mark	Symbol & Description	Part No.
	V701 Fluorescent indicator tube	AAV1043
	X701 Ceramic resonator	ASS1004

SP Switch assembly

SWITCHES

Mark	Symbol & Description	Part No.
★★	S852 Push switch (SURROUND)	ASG1017
★★	S851 Push switch (SPEAKER A, SPEAKER B)	SUJ5LXXS

RESISTORS

Mark	Symbol & Description	Part No.
★★	R851,R852	RS1PMF331J

OTHER

Mark	Symbol & Description	Part No.
	Phone jack (PHONES)	AKN1002

SP terminal assembly

SWITCH

Mark	Symbol & Description	Part No.
	S854 Slide Switch (SURROUND LEVEL)	ASH1003

RESISTORS

Mark	Symbol & Description	Part No.
	R856,R857	RS2LMF100J
	R854,R855	RS3LMF2R7J

OTHER

Mark	Symbol & Description	Part No.
	Terminal (SPEAKER)	AKE-111

Power SW assembly

SWITCH

Mark	Symbol & Description	Part No.
	S1 Push switch (POWER)	ASG1007

CAPACITOR

Mark	Symbol & Description	Part No.
	C1 Ceramic capacitor	ACG1002

8. PACKING

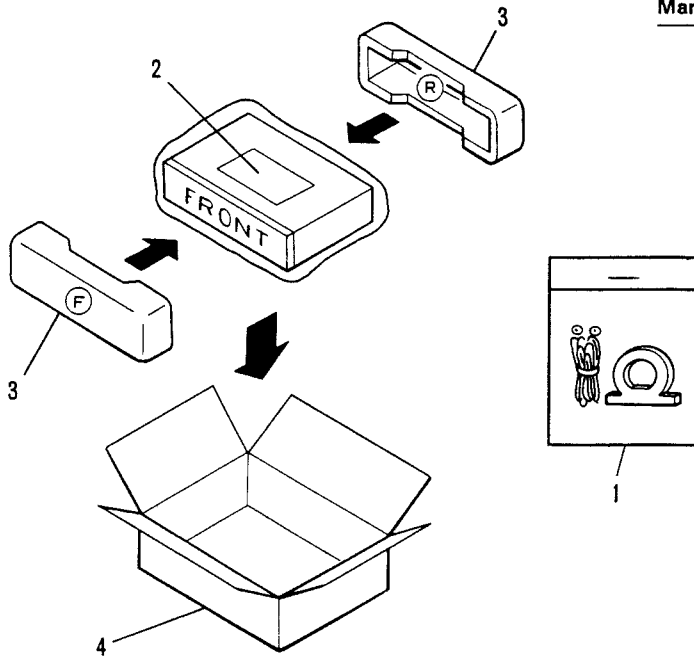

Mark	No.	Parts No.	Description
	1	AEA1002	Antenna set
	2	ARB1094	Operating instruction
	3	AHA1015	Front rear Pad
	4	AHD1328	Packing case

9. ADJUSTMENTS

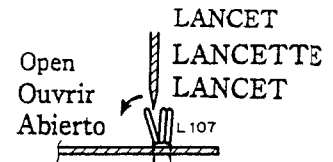
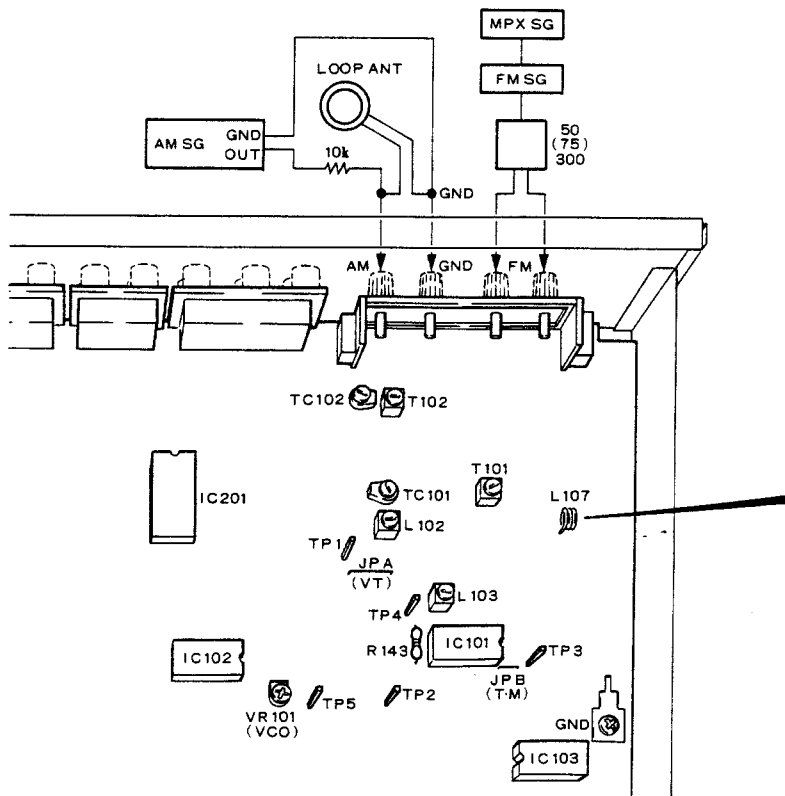

Ajusting L107
R'eglage de L107
Ajuste de L107

FM TUNER SECTION

- Connect the FM signal generator (FM SG) to the FM ANTENNA 300Ω terminal through a 300Ω dummy antenna.
- Set the SX-2300 or SX-1300 to the FM band.
- (*1) Tune the FM SG to the SX-2300/KUC or SX-1300/KUC.
- (*2) Connect the FM multiplex stereo signal generator to the FM SG external modulator terminal. Set the modulation to Main 1 kHz/L+R/±68.25kHz deviation. Pilot 19kHz/±6.75kHz deviation.

Step	FM SG (1kHz, ±75kHz deviation)		SX-2300 SX-1300 Frequency display	Adjustment point	Adjustment procedure
	Frequency	Level			
1	No signal		87.5MHz	—	Check DC voltage between terminal TP1(VT) and ground (2.5V-4V)
2	98.0MHz	30 to 40 dB	98.0MHz	T101 L107	Adjust DC voltage between IC101 13 pin and ground at maximum.
3	98.0MHz	60dB	98.0MHz	L103	Adjust DC voltage between terminal TP 3 and TP 4 to 0±50mV
4	98.0MHz(*1)	60dB	98.0MHz	VR101	Adjust signal between TP 5(VCO) and ground to 76kHz (within ±100Hz).
	no modulation				

AM TUNER SECTION







MW Tuner Section



- Connect the furnished AM loop antenna between terminals AM ANTENNA and GND.
- Connect the AM signal generator (AM SG) to the AM ANTENNA terminal through a 10kΩ resistor.
- Set the SX-2300 or SX-1300 to the AM(MW) band.
- (*3) There are 2 kinds of models in the SX-2300/SD and SX-1300/SD systems. The one is the channel step frequency of 10kHz and the other is 9kHz. Accordingly, in case of model 10kHz step, the adjustment should be performed by using the frequency of Item "10kHz step" and in case of model 9kHz step, the adjustment should be performed by using the frequency of Item "9kHz step".
- (*4) Tune the AM SG to the SX-2300 or SX-1300.

Step	AM SG (400Hz, 30% modulation)			SX-2300 SX-1300 Frequency display(*3)		Adjustment point	Adjustment procedure
	Frequency(*3)		Level	10kHz step	9kHz step		
	10kHz step	9kHz step					
1	No signal			530kHz	531kHz	L102	Adjust DC voltage between terminal TP 1(VT) and ground. (1.3±0.1V)
2	No signal			1600kHz	1602kHz	TC101	Adjust DC voltage between terminal TP 1(VT) and ground. (10±0.3V)
3	Repeat steps 1 and 2 until both specifications correct.						
4	600kHz(*4)	603kHz(*4)	76dB	600kHz	603kHz	T102	Adjust DC voltage between TP2 and ground at maximum.
5	1400kHz(*4)	1395kHz(*4)	76dB	1400kHz	1395kHz	TC102	
6	Repeat steps 4 and 5 until maximum sensitivity is attained.						
7	1000kHz	999kHz(*4)	45 to 65dB	1000kHz	999kHz	R161 4.7kΩ	However, remove the R161(4.7kΩ) from the COMPLEX assembly if the tuning indicator fails of light up at more than 65dB.

10. IC INFORMATION

PDG013 (MICROCOMPUTER)

Terminal No.	Terminal name	I/O	Condition	Terminal status	Remark
1	—	O	—	—	NOT USED
2	WAKE UP	I	POWER ON	H	When the terminal voltage remains low for more than 60 ns, this terminal enters the backup mode. When the terminal voltage becomes high, this terminal returns to its original mode.
3	REMOTE IN	I	Set to L.	L	(When this terminal is low, it does not receive key input.)
4	CLOCK	O			This terminal outputs "CLOCK" for control signals directed to IC201(TC9164N) and IC103(LM7001P).
5	DATA	O			This terminal outputs "DATA" for control signals directed to IC201(TC9164N) and IC103(LM7001P).
6	TUNER STEREO	I	INPUT PORT	L	When the output of IC102(AN7470P) pin 9 in the tuner unit is low, this terminal causes the FL display stereo indicator to go on.
7	TUNER STOP	I	INPUT PORT	L	When the output of IC101(LA1265S) pin 8 in the tuner unit is low, this terminal causes the FL display tuner indicator to go on.
8 15	KEY MATRIX OUTPUT	O			Detects the tact switch position.
16 18	—	O	—	—	NOT USED
19	ENABLE	O	While a control signal(DATA) is transmitted to IC103(LM7001)	H	Low while DATA is not transmitted.
20 25	KEY MATRIX INPUT	I			Detects the tact switch position.
26	—	O	—	—	NOT USED
27	FUNCTION IC STROBE	O	Immediately after transmitting DATA to IC201(TC9164N)		Instantaneously becomes high after transmitting a control signal to FUNCTION IC201(TC9164N)
28	TUNER AUTO MONO	O	When the system is in the FM "MONO" mode	H	Set the FM MODE switch to MONO.
29	SIMULATED STEREO	O	When the SIMULATED STEREO is operating	H	When the ON/OFF switch of the SIMULATED STEREO is turned on.
30,31	—	O	—	—	NOT USED
32	Vss	—	GND	OV	
33 48	SEGMENT	O			This is a SEGMENT control terminal for the FL display.
49 56	GRID	O			This is a GRID control terminal for the FL display.
57	VFDP	I		-29V	This is a power supply terminal for a resistor (incorporated in IC701) to pull down control terminals 33 to 56 for SEGMENT and GRID.

Terminal No.	Terminal name	I/O	Condition	Terminal status	Remark
58	INT2	O	(NOT USED)		Does not function in the program.
59	INT1	O			
60	Xtal	O	When connected to a crystal vibrator(4.19 MHz)		
61	Extal	I			
62	RESET		When the 5V power source is turned on		When data is written in the microcomputer memory, this terminal causes the system to start from the state before the power supply was interrupted. When data in the microcomputer memory is erased, this terminal causes the system to start from the initial state.
63	—	O			NOT USED
64	VDD	—	5V power source	5V	

11. FOR SX-2300/SD, SX-1300/KUC AND /SD MODELS

NOTES:

- Parts without part number cannot be supplied.
- The Δ mark found on some component parts indicates the importance of the safety factor of the part. Therefore, when replacing, be sure to use parts of identical designation.
- For your parts Stock Control, the fast moving items are indicated with the marks $\star\star$ and \star .
 $\star\star$ **GENERALLY MOVES FASTER THAN \star**
 This classification shall be adjusted by each distributor because it depends on model number, temperature, humidity, etc.
- Parts marked by "●" are not always kept in stock. Their delivery time may be longer than usual or they may be unavailable.

CONTRAST OF MISCELLANEOUS PARTS

The SX - 2300/SD and SX - 1300/KUC,SD types are the same as the SX - 2300/KUC type with the exception of the following sections.

Mark	Symbol & Description	Part No.				Remarks
		SX-2300/ KUC type	SX-2300/ SD type	SX-1300/ KUC type	SX-1300/ SD type	
	Complex assembly	AWZ1419	AWZ1759	AWZ1497	AWZ1759	
	Control assembly	AWZ1492	AWZ1761	AWZ1498	AWZ1761	
	SP switch assembly	Non Supply	Non Supply	Non Supply	Non Supply	
	SP Terminal assembly	Non Supply	Non Supply	Non Supply	Non Supply	
Δ	AC power cord	ADG1031	ADG1015	ADG1031	ADG1015	
$\Delta\star\star$	FU1 Fuse (4A)	AEK-100	
$\Delta\star\star$	FU1,FU2 Fuse (2A)	AEK-122	
$\Delta\star\star$	FU1 Fuse (3.15A)	AEK-1004	
$\Delta\star\star$	FU1,FU2 Fuse (1.6A)	AEK-121	
Δ	Fuse Holder	AKR-038	AKR-038	
$\Delta\star\star$	S2 Line Voltage selector	AKX-507	AKX-507	
	Oprating instructions (Spanish)	ARC1071	ARC1071	
$\star\star$	S3 Slide switch	ASH-004	ASH-004	
$\Delta \star$	T1 Power transformer (120V)	ATRS1118	ATS1118	
Δ	T1 Power transformer (110V/120-127V/220V/240V)	ATS1129	ATS1130	
	Knob(SURROUND)	AAD1162	AAD1162	
	Front Panel	ANB1166	ANB1166	ANB1165	ANB1165	
	Coil Spring	ABH1034	ABH1034	
	Packing Case	AHD1328	AHD1328	AHD1329	AHD1329	
$\Delta\star\star$	Q1,Q2 Transistor	2SC3181N	2SC3181N	2SC3180N	2SC3180N	
$\Delta\star\star$	Q3,Q4 Transistor	2SA1264N	2SA1264N	2SA1263N	2SA1263N	

NOTES:

- Parts without part number cannot be supplied.
- Parts marked by "⊙" are not always kept in stock. Their delivery time may be longer than usual or they may be unavailable.
- The Δ mark found on some component parts indicates the importance of the safety factor of the part. Therefore, when replacing, be sure to use parts of identical designation.
- For your parts Stock Control, the fast moving items are indicated with the marks **★★** and **★**.
- **★★ GENERALLY MOVES FASTER THAN ★**
This classification shall be adjusted by each distributor because it depends on model number, temperature, humidity, etc.
- When ordering resistors, first convert resistance values into code form as shown in the following examples.

Ex. 1 When there are 2 effective digits (any digit apart from 0), such as 560 ohm and 47k ohm (tolerance is shown by J = 5%, and K = 10%).

560Ω	56 × 10 ¹	561.....	RD1/4PS	⊙	⊙	⊙	J
47kΩ	47 × 10 ³	473.....	RD1/4PS	⊙	⊙	⊙	J
0.5Ω	0R5.....		RN2H	⊙	⊙	⊙	K
1Ω	010.....		RS1P	⊙	⊙	⊙	K

Ex. 2 When there are 3 effective digits (such as in high precision metal film resistors).

5.62kΩ	562 × 10 ¹	5621.....	RN1/4SR	⊙	⊙	⊙	F
--------	-----------------------	-----------	---------	---	---	---	---

COMPLEX ASSEMBLY

The **COMPLEX ASSEMBLY** (For AWZ 1759 and AWZ 1497,AWZ1759)is the same as the **COMPLEX ASSEMBLY**(AWZ1491)with the exception of the following sections.

Mark	Symbol & Description	Part No.				Remarks
		AWZ1491	AWZ1759	AWZ1497	AWZ1760	
	C152,C153	CQMA125K50	CQMA122K50	CQMA125K50	CQMA122K50	
	C601	CEHAQ470M35	CEAS470M35	CEHAQ470M35	CEAS470M35	
	C523,C524	CEAS2R2M50	CEAS2R2M50	
	C606,C607 Electrolytic capacitor	ACH1031	ACH1031	ACH-252	ACH-252	
	C801	CEAS2R2M50	CEAS2R2M50	
	C802	CQMA332K50	CQMA332K50	
	C803	CKDYB331K50	CKDYB331K50	
	C804	CEAS4R7M50	CEAS4R7M50	
	CN12	KPC3	KPC3	
★★	IC801	M5218PF	M5218PF	
★★	IC802	M5201P	M5201P	
★★	Q509,Q510	2SC2238	2SC2238	2SC2235	2SC2235	
★★	Q511,Q512	2SA968	2SA968	2SA965	2SA965	
★★	Q523,Q524	2SC1845	2SC1845	
	D507-D510	1SS252	1SS252	
	R513,R514	RD1/4PM681J	RD1/4PM681J	RD1/4PM821J	RD1/4PM821J	
	R611	ACN-209	ACN-209	ACN-209	
	R549-R552	RD1/8PM⊙⊙J	RD1/8PM⊙⊙J	
	R563,R564	RD1/8PM681J	RD1/8PM681J	RD1/8PM821J	RD1/8PM821J	
	R601	RS2LMF162J	JS2LMF162J	RS2LMF122J	RS2LMF122J	
	R602	RS2LMF182J	RS2LM182J	RS2LMF152J	RS2LM152J	
	R607	RS1LMF362J	RS1LMF362J	RS1LMF302J	RS1LMF302J	
	R608	RS1PMF122J	RS1PMF122J	RS1PMF911J	RS1PMF911J	
	R615	RFA1/4PS101J	RFA1/4PS101J	
	R801,R803-R809,R811-R815	RD1/8PM⊙⊙J	RD1/8PM⊙⊙J	
★★	RY504 RELAY	ASR-112	ASR-112	ASR-111	ASR-111	

CONTROL ASSEMBLY

The CONTROL ASSEMBLY (For AWZ1761 and AWZ1498, AWZ1761) is the same as the CONTROL ASSEMBLY (AWZ1491) with the exception of the following sections.

Mark	Symbol & Description	Part No.				Remarks
		AWZ1492	AWZ1761	AWZ1498	AWZ1761	
	R704	RD1/8PM473J	RD1/8PM473J	
	R715	RD1/8PM102J	RD1/8PM473J	
★★	S717	ASG-711	ASG-711	
★	D705,D706	1SS252	

SP SWITCH ASSEMBLY

The SP SWITCH ASSEMBLY (For SX-1300/KUC and SX-1300/SD types) is the same as the SP SWITCH ASSEMBLY (SX-2300/KUC type) with the exception of the following sections.

Mark	Symbol & Description	Part No.			Remarks
		SX-2300/ KUC type	SX-1300/ KUC type	SX-1300/ SD type	
★★	S851	SUJ5LXXS	SUJ5LYXS	SUJ5LYXS	
★★	S852	ASG1017	

SP TERMINAL ASSEMBLY

The SP TERMINAL ASSEMBLY (For SX-1300/KUC and SX-1300/SD types) is the same as the SP TERMINAL ASSEMBLY (SX-2300/KUC type) with the exception of the following sections.

Mark	Symbol & Description	Part No.			Remarks
		SX-2300/ KUC type	SX-1300/ KUC type	SX-1300/ SD type	
	R854-R856	RS2LMF4R7J	
	R857	RS2LMF100J	
★★	S854	ASH1003	